

BREACH



Designed & Written By

William G. M. Leslie III & Thomas R. Carbone

Cover Artwork By

Les Howe and Pamela Hopson

Title Screen & Manual Illustrations By

Kurt Hoover

Manual Printed By

The Repich Group, Inc.

Beta Testing By

Haywood Nichols, Michael Gilchrist, Arlon Harris, Hosea Battles,
Steve Nolan, Ray Morrison, and Ron Hills

Copyright

The enclosed software is copyrighted and all rights are reserved by Omnitrend Software, Inc. Copying (except for one backup), duplicating, selling, renting, or otherwise distributing this product is a violation of the law.

The enclosed manual is copyrighted and all rights are reserved by Omnitrend Software, Inc. The manual may not, in whole or part, be copied, photocopied, reproduced, translated, or reduced to any electronic medium or machine-readable form.

Willful violations of the Copyright Law of the United States can result in civil damages of up to \$50,000 in addition to actual damages, plus criminal penalties of up to one year imprisonment and/or a \$10,000 fine. (And we'll send you an alien beast in the mail. A hungry one. A *really* hungry one.)

Atari ST is a Trademark of the Atari Corporation.
Macintosh is a Trademark of Apple Computer, Inc.

Portions of the Atari ST version of this product are Copyright © 1986 OSS and CCD. Used by permission of OSS.

Breach © 1987 Omnitrend Software, Inc.

Printed and Manufactured in the United States of America

TABLE OF CONTENTS

1	Before You Play...		Delete...
	Back-up Those Disks!		Save
	Problems Running Breach		Close
	Limited Media Warranty	16	Quit
	Limited Software Warranty		Mission Briefing
2	Playing Notes		Victory Conditions
			Mission Status
	Playing Breach		Your Marines
3	Notes		Basic Characteristics
	Starting Breach	17	Movement
	Security Check	18	Combat
	Starting a New Game	19	Types of Marines
4	Order of Play	21	
5	Movement Points		The Opponents
	Deploying Your Squad		Basic Characteristics
6	Encumbrance	23	Marines
	Mission Briefing		Beasts
	Victory Conditions		Aliens
7	Mission Status		Battle Robots
	Fighting the Enemy	24	Overlords
	Improving Your Squad Leader		Autoguns
8	Saving a Game in Progress		
	Closing a Game Without Saving		Objects and Their Uses
	Quitting Breach	25	Encumbrance Points
			What They Are and How to Use Them
	The Battle Displays		Terrain
9	The Combat Window		Interior Terrain
	The Marine Statistics Window		Exterior Terrain
10	Countdown Timer	28	Special Terrain
	Wideview Display		Terrain Table
	The Icons	29	Scenario Builder
11	Drop Object		File Menu
	Use Shaft		Edit Menu
	Take Object	30	Level Menu
12	Use Object		Palette Menu
	Open Door	32	Other Functions
13	Fire Gun/Psionic Stun		Scenario Design Notes
14	Next Button		
	Change Scale Button		The Scenarios
	The Menus	34	
15	About Breach...		
	New		
	Resume...		

Back-up Those Disks!

Breach is not copy protected and we encourage you to back-up your disks prior to play. In fact, if you haven't done so already, now would probably be a good time!

Problems Running Breach

Should you experience a problem in running this software on your computer, Omnitrend Software, Inc. provides telephone assistance several times per week. Call (203) 658-6917 for the current assistance schedule. *We regret that we cannot answer any questions regarding the play of the game or provide hints.*

Should you run across a bug in the program, please drop us a note. Be sure to include the version number of the game (this can be found on the "About Breach..." dialog box) as well as a description of the computer you are using. All correspondence regarding the game should be mailed to:

Omnitrend Software, Inc.
MailStop 101
PO Box 733
West Simsbury, CT 06092

Limited Media Warranty

Omnitrend Software, Inc. warrants all media for a period of ninety (90) days from the date of purchase. Should you experience a problem within that period, return the defective disk along with dated proof-of-purchase. Should you have a problem out of warranty, Omnitrend Software, Inc. will replace a defective disk for \$6.00. We regret that we will be unable to return any packing materials you use to ship your disk.

Defective disks should be returned to:

Omnitrend Software, Inc.
MailStop 100
PO Box 733
West Simsbury, CT 06092

Omnitrend Software, Inc. will not be responsible for replacing free of charge media within warranty that has been subjected to misuse, damage, or excessive wear.

Limited Software Warranty

This software and the enclosed manual are sold "As is" without warranty to their performance. The entire risk as to the results and performance of the program is assumed by you.

The Limited Software Warranty is the only warranty of any kind, either expressed or implied, including but not limited to the implied warranties of merchantability and fitness for a particular purpose that is made by Omnitrend Software, Inc.

Neither Omnitrend Software, Inc. nor anyone else who has been involved in the creation, production, or delivery of this program shall be liable for any direct, indirect, consequential, or incidental damages arising out of the use, the results of use, or inability to use such product even if Omnitrend Software, Inc. has been advised of the possibility of such damages or claim. Some states do not allow the exclusion or limitation of liability for consequential or incidental damages, so the above limitation may not apply to you.

BEFORE YOU PLAY...

Atari ST Notes

Your computer must be in low resolution mode in order to play.

Due to bugs in some versions of the ST, use of the underscore character when entering file names will cause the computer to stop.

When playing Breach with only one drive, you must copy a scenario (.SCE) file and a squad leader (.SQL) file from the scenario disk to the program disk before playing.

Breach uses almost 512K of memory. If the program reports that there is not enough memory, you may need to remove any RAMdisks or desk accessories (.ACC) files and reboot.

Macintosh Notes

When booting the Breach disk, the Breach program will run automatically.

To run the scenario builder, use the "Quit to scenario" option in the Breach program.

Notes

Whenever the manual refers to "the mouse button", and your mouse has more than one button, use the left-hand button. Breach only uses the left-hand button.

"Clicking" means "press the mouse button". "Shift-click" means "hold down one of the shift keys and press the mouse button at the same time".

The "current marine" referred to throughout the manual, is the marine who appears in the center of the Combat Window and whose statistics appear in the Marine Statistics Window.

Starting Breach

To play Breach, boot up the Breach Program Disk and double-click the "BREACH" icon (Breach will come up automatically on the Macintosh). When the program finishes loading, the Breach title screen will appear. To continue, click the mouse or press any key on the keyboard.



Security Check

In order to play Breach, you must correctly complete a security check. To complete the security check, enter the word from this manual whose location is given by the dialog box. "Words" are any string of characters with a space or punctuation at either end. Once you have entered the correct word, the program will continue.

Starting a New Game

Select "New..." from the Scenario menu. An item selector box will appear. All of the names that appear are scenario files. These scenario files contain all the data for your combat squad, the opponents, and maps of the combat area. What you are going to create is a game file. This is a combination of a scenario file and a squad leader file. More on the squad leader file later.

PLAYING BREACH

Once you have selected a scenario file, the scenario item selector box will be replaced by a squad leader selector box. This is where you select the squad leader for your game. A sample squad leader "SMITH" is included with your game. Later on, you'll probably want to create a squad leader of your own using the Scenario Builder.

Now you have to name the game file in which your current game is going to be stored.

Once you have done this, the program will save the new game file to the disk and your game will start.

Important – When a game file is created, it erases the squad leader file you have selected and incorporates it into the game file. This ensures that the squad leader file can be used only by one scenario at a time. The only ways to recover the squad leader file are: win the game in progress or delete the scenario with the "Delete..." menu entry. Deleting a game file outside of the game will also erase the squad leader file which has been incorporated into it.

Order of Play

Player Phase – Each round begins with the player having the option to move all, some, or none of his marines. You can move a marine until he runs out of movement points or you click the Next icon.

To enter the enemy combat phase, shift click the Next icon. If all of your marines have used up their movement points for the round, the computer will automatically enter the Enemy Phase.

Each Player Phase takes 30 seconds of game time.

Enemy Phase – When the enemy attack phase begins, the marine statistics window will change its title to "Attacks" and the legend "Enemy Movement..." will appear.

Enemy troops appear in the combat window only when they are attacking your men.

At the end of the enemy phase, the player phase begins again.



Movement Points

Each marine is given a certain quantity of movement points (mp). All of the marine activities except for changing the view scale (more on that later) take up a certain number of points. For example, moving onto a clear terrain square costs 2 mp, while firing a gun takes 5 mp. The combat activities such as taking an object, firing the gun, moving, and using an object can all be mixed at your discretion during the same turn.

If you do not have sufficient mp for the activity you want to perform, the computer will inform you with an alert box.

If all of the movement points for the current marine have been exhausted, the program will automatically advance to the next marine in the squad.

Movement points for each marine are based on: the marine's suit type, the vitality of the marine, and the marine's current encumbrance.

Deploying Your Squad

The marines in your squad always enter the scenario through the entry square. The entry square must be clear in order for your marines to enter. If a marine is unable to enter, the program will jump to the enemy combat phase.

You can continue moving a marine until he runs out of movement points, gets stunned, or you click the Next icon. Each time you click Next, the program will advance to the next marine in the squad who is in the combat zone, is not stunned, and has at least one movement point.

In addition, you can make any marine who is visible in the combat window the current marine by holding down the Alternate key and clicking the desired marine. (Macintosh players should use the Option key instead of the Alternate key.)

Since marines carry only their guns and armor into a scenario, many scenarios provide a staging area where the marines pick up additional equipment which has been placed near the entry square.

If detectors and crack units are available, use them whenever possible. By saving time searching for your objects, you raise the odds of successfully completing your mission.

PLAYING BREACH

Encumbrance

There are fifteen different types of objects which may be found in a scenario. Each of those objects has an encumbrance value. Encumbrance is a measure of the object's bulk. Obviously, the bulkier the type of object, the fewer of them the marine may carry.

Carrying a large number of encumbrance points has two disadvantages. One, the weight reduces the number of available mp's per turn. Two, marines carrying a large quantity of encumbrance points are more likely to be selected as a target by enemy forces.

Mission Briefing

The mission briefing is a short description of your combat mission.

Briefings usually include information as to the type and strength of enemy you will be fighting and hints as to the location of any mission objectives.

Victory Conditions

The victory conditions are:

Rescue prisoners – You must rescue all of the prisoners in the scenario if this is one of the victory conditions.

Capture data packs – This works the same way as rescue prisoners.

Exit combat zone – All of the marines in your squad must find and use the exit square if this is one of the victory conditions.

Kill n% opponents – At least n% of the opponents in the scenario must be killed if this is one of the victory conditions.

Scenario time limit – All of the other victory conditions in the game must be satisfied before the time limit expires. All scenarios have a time limit.

All of the victory conditions are non-exclusive, that is, more than one may be in effect for a given scenario. Thus, in order to complete a scenario you may have to rescue prisoners and move all of the squad's marines through the exit square before the time limit expires.

Mission Status

By using the Mission Status function, you can tell which victory conditions have been satisfied and which need more work.

The possible status displays are:

Victory Condition	Complete	Incomplete
Rescue Prisoners	All prisoners recovered	Not all prisoners recovered.
Capture Datapacks	All datapacks recovered	Not all datapacks recovered.
Kill n% Opponents	Kill objective completed	More casualties needed

Fighting the Enemy

If the enemy is using grenades and rockets, avoid clustering your marines. Try to keep at least one square between each one. This way, you avoid having three or four casualties from a single grenade blast.

Conversely, grenades and rockets are most effective against clusters of the enemy. Unless you have a large quantity of grenades or rockets, it is wisest not to "waste" these weapons against single targets.

Battle robots are very dangerous opponents. Two hits from their cannon are enough to destroy virtually any marine. In addition, they move quickly and their armor is quite tough. It is a good idea to use grenades against battle tanks before trying to destroy them with your marine's guns.

Improving Your Squad Leader

Your overall objective is to improve your squad leader. You do this by successfully completing scenarios.

The more active a squad leader is, the more likely he will see some kind of improvement at the end of a successful scenario. Shooting accuracy is very important but cracking and detecting skills should be honed as well.

It is rumored that squad leaders who are excellent shots and have a passing knowledge of detecting and cracking are sent to a special advanced training school (STAR) which gives them the skills necessary to complete a STAR level scenario.

PLAYING BREACH

Saving a Game in Progress

In order to save a game in progress, you must be at the beginning of the Player Movement phase. You may select menu entires, but clicking any of the icons or the combat window will prevent you from saving your game. This is the only point at which you can save the game before quitting.

Closing a Game Without Saving

Select "Close" from the Scenario menu. When the program asks you if you want to save the game, click No.

Quitting Breach

Use "Quit" from the Scenario menu to exit the program. If you select this at the beginning of the Player Movement phase, you will be given the option of saving your progress before closing. At any other point, the program will quit without saving.

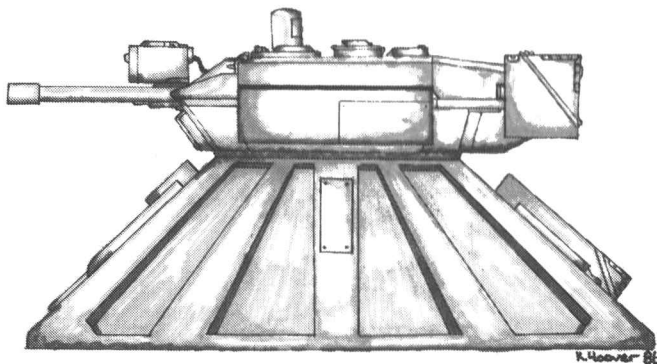

THE BATTLE DISPLAYS

The Combat Window

The combat window is the largest window on the screen. During the player combat phase, the current player marine will always appear in the center of the combat window. During the enemy combat phase, the current enemy marine will appear in the center of the combat window.

The Marine Statistics Window

The marine statistics window has several functions. During the Enemy Combat phase, information on enemy attacks are shown in the marine statistics window. During the Player Combat phase, this window displays the battle statistics for the current player marine. These statistics are:

Moves – the number of moves left in the current marine's turn.

Vital – the vitality of the current marine. If the vitality drops below 30%, it will be displayed in red as a warning (Macintosh version excluded).

Health – the health of the current marine. If this goes to 0%, the marine is dead. When the current marine's health falls below 50%, it will be displayed in red as a warning (Macintosh version excluded).

Enc – the current encumbrance of the marine (not the maximum encumbrance). This figure will be displayed in green if it is greater than 0. This serves as a reminder that the marine is carrying an object (Macintosh version excluded).

Shoot – the accuracy of the current marine's shooting. If the marine is also a psionic talent, this is a measure of his stun accuracy as well.

Detec – the percentage chance the current marine has of successfully operating a detector.

Crack – the percentage chance the current marine has of successfully operating a crack unit.

Ammo – the current marine's ammunition supply in his gun. This figure does not include ammunition in ammo clips he may be carrying. Ammo clips must be used in order for their ammo to be added into this figure.

THE BATTLE DISPLAYS

Countdown Timer

The countdown timer displays the amount of time remaining in the scenario.

Wideview Display

The wideview display is a 21 by 21 composite map of the terrain surrounding the current marine. It can be displayed by clicking on the Change Scale icon. Information for this wideview is provided by other marines moving through the area, scouts using detectors, and infiltrators using crack units. When scouts use wideview, opponents appear as flashing green squares on the Atari ST, and as grey squares on the Macintosh.

Drop Object



Click this icon to drop an object.

A dialog box will appear with a list of all the objects the current marine is carrying. Note that the marine's gun and armor will not appear on this list as they may not be removed. If the marine is carrying more than five objects, the space between the dialog box scrolling arrows will turn grey. Click on the name of the object you want to drop and then click "Ok".

There are several reasons you might want to drop something. A very good reason is that you no longer want to carry something because of its encumbrance penalty. You might want to transfer an object from one marine to another. In addition, the shield works only if you drop it.

A dropped object always lands directly underneath the current marine. Only one object may be in a square at a time.

It takes 1 movement point to drop an object.

Use Shaft



Click this icon whenever you are on a liftshaft/dropshaft that you want to use.

If the corresponding square above the liftshaft (or below the dropshaft) is blocked by another marine, the mouse pointer will change into a stop sign. If the corresponding square is blocked by an opponent, the opponent will be killed and your level will be changed.

It takes 5 movement points to use a shaft.

Take Object



Click this icon to take an object.

You can take any object directly adjacent to or in the same square as the current marine. The object must be visible; you cannot take an object directly from another marine.

The mouse pointer will turn into a pointing hand. Click this on the object you wish to take.

Some objects have special messages written on them. These messages appear whenever the object is taken.

THE ICONS

Whenever an object is taken, it increases the marine's total encumbrance. Encumbrance affects the number of movement points your marine will receive at the beginning of a turn. Therefore, heavily laden marines will not move at their highest speed.

It takes 1 movement point to take an object.

Use Object



Click this icon to use an object.

A dialog box will appear with a list of all the objects the current marine is carrying. If the marine is carrying more than five objects, the space between the dialog box scrolling arrows will turn grey. Click on the name of the object you want to use and then click "Ok".

All of the objects and their uses are detailed in the section "Objects and Their Uses."

The objects require varying amounts of movement points to use. They are:

<u>Object</u>	<u>Movement Points</u>
Grenade	5
Demo Charge	5
Stimulant	3
Ammo	8
MediKit	7
Rocket	5
Launcher	5
Crack Unit	9
Detector	15
Shield	N/A ¹
Grav Belt	10
Prisoner	N/A
Datapack	N/A

¹Shield is activated by dropping it.

Open Door



Click this icon to open a door adjacent to the current marine.

The mouse point will turn into a small key. Place this key over the door you want to open and click the mouse. If you have enough movement points, the door will open.

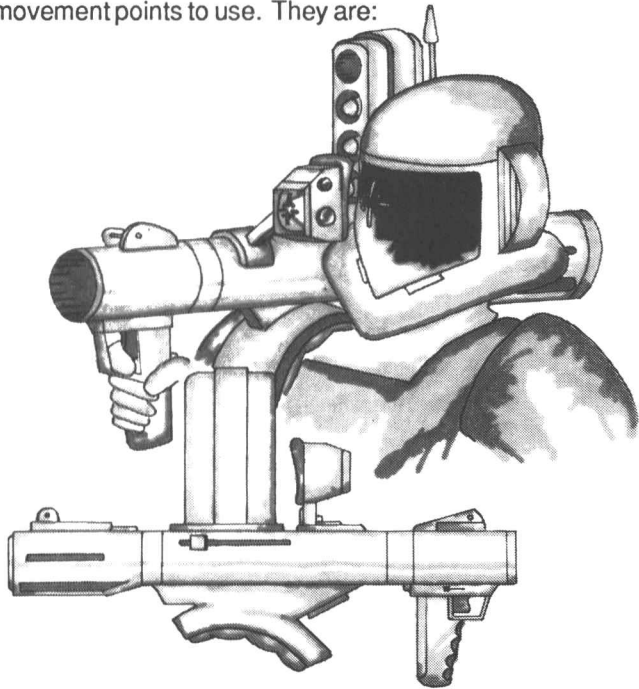

The doors require varying amounts of movement points to open. Glass doors require 3, Steel doors require 5, and Power doors require 10.

Fire Gun/Psionic Stun



Click this icon to fire the current marine's gun.

The gun will fire in the direction that the marine faces. Each firing consumes one round of ammo.

Whenever this icon is clicked and there is at least one round of ammo in the current marine's gun, a beam of energy will be emitted.

This beam will travel in a straight line away from the marine until it strikes: a wall, solid rock, a shaft, a closed door, a fuel tank, an opponent, or one of your own men.

When a beam stops in a particular square, the computer determines whether or not the beam hit the target. This is based on the current marine's accuracy percentage. If the beam does hit the target, a "splash" of energy will appear on the target. This holds true for the opponents as well. If the beam hits an opponent, the amount of health damage that the gun generates is subtracted from the opponent's health, minus the amount of protection his armor provides.

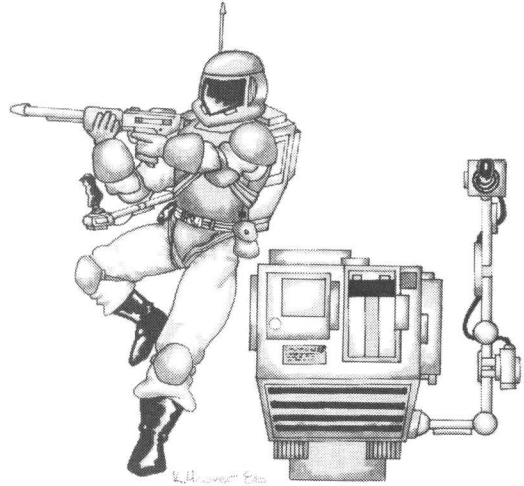

	Suit Protection	Gun Damage
Squad Leader	75%	40%
Marauder	55%	30%
Scout	55%	15%
Infiltrator	45%	15%
Psionic Talent	0% ¹	15%
Enemy Marine	55%	30%
Alien	45%	15%
Beast	0% ²	15%
Overlord	55%	40%
Battle Robot	75%	40%
Autogun	75%	40%

¹Psionic talents carry a gun which is only effective against injured or damaged opponents.

²Beasts' biting generates 45% damage.

THE ICONS

For example, an enemy marine (suit protection = 30%) is hit by a shot from your squad leader (gun damage = 75%). The result is that the enemy marine would lose 45% health (75% - 30% = 45% loss).

The same holds true for your own marines. Note that it is possible to shoot your own troops by mistake, so look before you fire.

Fuel tanks are useful to hit, as long as you aren't too close to them when they explode. Being in the midsts of a fuel tank explosion is the equivalent of standing on a demo charge when it goes off. However, if you can position your marines correctly, this effect can be exploited with impressive results. A word of warning: fuel tanks will chain-react.

Psionic Talent type marines execute psionic attacks by shift clicking the gun icon. Enemies successfully stunned by a psionic talent will not be able to move or fire during the next enemy attack phase.

Firing a gun requires 3 movement points. A psionic attack requires 10 movement points.

Next Button



Click this button to switch current marines. This will advance you to the next marine in your squad or, if you have just moved the last marine in the squad, loop back to the squad leader. Shift click the Next button to enter the Enemy Combat phase.

Change Scale Button

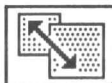

Click this button to get a "wide angle" view of the surrounding terrain. Information for this wideview is provided by other marines moving through the area, scouts using detectors, and infiltrators using crack units. When scouts use the wideview, opponents will appear as flashing green squares on the Atari ST and as grey squares on the Macintosh.

About Breach...

The "About Breach..." entry displays a dialog box with information about the program version and release date.

New...

"New..." is used to start a new game. This is a three stage process.

First, select the scenario you wish to play. Next, select a squad leader. If there aren't any squad leader files on the disk, you will have to create a new one with the Scenario Builder program. Finally, enter the name under which this current game is to be saved.

When all this has been done, Breach will create a game file, which means that you now have a game in progress on the disk.

Resume...

Use "Resume..." to continue a game already in progress.

Delete...

Use "Delete..." to delete game files. An item selector will appear with the names of all the games in progress. Select any one of these.

Note that deleting a game file will restore the incorporated squad leader file.

Save

"Save" will save your current progress to the disk and continue play. You may only save at the beginning of the Combat Phase.

Close

Use "Close" to stop a game in progress. If you select this at the beginning of the Combat Phase, you will be given the option to save your progress before closing. At any other character's point, the program will stop the current game without saving.

THE MENUS

Quit

Use "Quit" to exit the program. If you select this at the beginning of the Combat Phase, you will be given the option to save your progress before closing. At any other point, the program will quit without saving.

Mission Briefing

The mission briefing display contains background information for the mission and possibly clues as to the locations and strengths of your objectives.

Victory Conditions

The victory conditions dialog box displays the objectives which must be completed in order to win the game.

Mission Status

The mission status dialog box displays whether or not each of the scenario's objectives have been met.

Basic Characteristics

Movement Points – Each marine is given a certain amount of movement points at the beginning of his turn. Almost all of the activities a marine can perform use movement points (mp). For example, moving onto a clear terrain square costs 2 mp, while firing a gun takes 3 mp.

Combat activities such as taking an object, firing the gun, moving, and using an object can all be mixed at your discretion.

If you do not have sufficient mp for the activity you want to perform, the computer will inform you with an alert box.

If all of the movement points for the current marine have been exhausted, the program will automatically advance to the next marine in the squad or loop back to the squad leader if you were on the last marine in the squad.

Movement points allocated to each marine are based on the marine's suit type, the vitality of the marine, and the marine's current encumbrance.

Vitality – Vitality is a measure of how well-rested a marine is. The higher the vitality, the more moves a marine has available in subsequent turns. If a marine were at the 50% vitality level, he would have 50% of his maximum number of moves available.

At the beginning of a game, a marine's vitality is always 100%. As a marine moves about, his vitality is reduced at the same rate as his movement points. So if a marine with 100% vitality fired a gun (3 mp) his new vitality would be 97%. Vitality is replenished at the rate of health% divided by 4, which means the maximum rate of replenishment is 25% per turn ($100\% \text{ health} / 4 = 25\%$).

If a marine's vitality is 0%, then the marine is considered stunned, and he may not move until the next round.

Health – Health is a measurement of the amount of damage a marine can absorb before dying. When a marine's health drops to 0%, he has died.



YOUR MARINES

Above 50% health, a marine cannot be killed while taking hits. Below 50%, however, a marine can die while being hit, even if the hit does not drop his health to 0%. As the marine's health falls closer to 0%, the likelihood of this occurring is much greater.

Encumbrance – This is a measure of how many objects a marine can carry.

Carrying a large number of encumbrance points has two disadvantages. One, the weight reduces the number of available mp's per turn. Two, the marine is more likely to be selected as a target by enemy forces.

Shooting – Shooting is the measurement of a marine's accuracy with a gun. For marines with psionic talent, this is also a measure of their accuracy with psionic stuns.

Detecting – Detecting is the measurement of how well a marine uses a detector.

Cracking – Cracking is the measurement of how well a marine uses a crack unit.

Movement

As with any other function, moving your marine will consume some movement points. Each terrain type (grass, rocks, grating) consumes a different amount of mp when it is entered. In order to move your current marine into a new square, he must have at least as many mp as are required to enter the square.

<u>Terrain Type</u>	<u>MP Required</u>	<u>Terrain Type</u>	<u>MP Required</u>
Clear	2	Computer	5
Dirt	2	Terminal	5
Grass	2	Bed	5
Light Vegetation	4	Bureau	6
Heavy Vegetation	6	Table	5
Rocky Dirt	4	Small Chair	4
Rubble	4	Worker	6
Stun Field	8	Entry & Exit	3
Stepping Stones	4	Machinery	6
Grating	3	Dirt/Water	4
Shaft	5	Empty/Water	4
Open Door	4	Command Chair	4

The current marine will always occupy the center of the combat window.

Marines can move in the four compass directions. To move the marine to a particular square on his current row or column, simply click the mouse on it. The marine will march into the square or as far as is possible before running into a wall or running out of movement points.

If the marine does not have enough mp to move into the square, the square is not of a type that the marine may occupy, the square is occupied by another player marine, or the square is already occupied by an opponent, the mouse pointer will turn into a stop sign, indicating movement is not allowed.

To change a marine's facing without having to move the marine from his current square, hold either shift key down and click on the adjacent square you wish the marine to face. This takes 1 movement point (mp).

In addition, you can make any marine who is visible in the combat window the current marine by holding down the Alternate key and clicking the desired marine. (Macintosh players should use the Option key instead of the Alternate key.)

Combat

Guns – All marines carry rifle-type energy weapons called "blasters". Your marines carry 4 different types of blasters. Each specialty carries a specific one. These guns may not be transferred or exchanged nor can they be destroyed by enemy fire.

Specialty	Gun Strength
Squad Leader	75%
Marauder	55%
Scout	55%
Infiltrator	45%
Psionic Talent	0% ¹

¹Psionic talents carry a gun which is only effective against injured or damaged opponents.

Regardless of weapon strength, all guns use one round of ammo per firing. In addition, all of the blasters use the same ammo clips.

Use caution when shooting around fuel tanks! A hit from any blaster will cause them to explode.

It takes 3 mp to fire a blaster.

YOUR MARINES

Grenades – Marines equip themselves with grenades by taking them from the surrounding terrain.

Grenades will explode around friendly troops and it is possible to detonate one in the same square as the current marine. Grenades will also detonate fuel tanks in the same fashion as blasters. Caution must be exercised when using grenades!

Grenades explode in a 3 by 3 pattern, with the target in the center. Each square receives the equivalent of a hit from a 90% blaster.

Demo Charges – Marines equip themselves with demo charges by taking them from the surrounding terrain.

When a demo charge is activated, it drops into the current marine's square. The demo charge ignores any objects which may already be in the square.

Demo charges will explode around friendly troops and it is possible to detonate one in the same square as the current marine. Demo charges will also detonate fuel tanks in the same fashion as blasters. Caution must be exercised when using demo charges!

Demo charges explode in a 5 by 5 pattern, with the target in the center. Each square receives the equivalent of a hit from a 100% blaster.

Caution: Once a demo charge has been activated, it cannot be aborted, but will explode at the end of the current marine's turn.

Rocket Launchers – Marines equip themselves with rockets and launchers by taking them from the surrounding terrain.

A marine must have at least one rocket and one launcher in order to fire.

When a rocket is fired, it travels in a straight line until it hits a valid target (i.e., a wall, a marine, etc.) or leaves the edge of the combat zone.

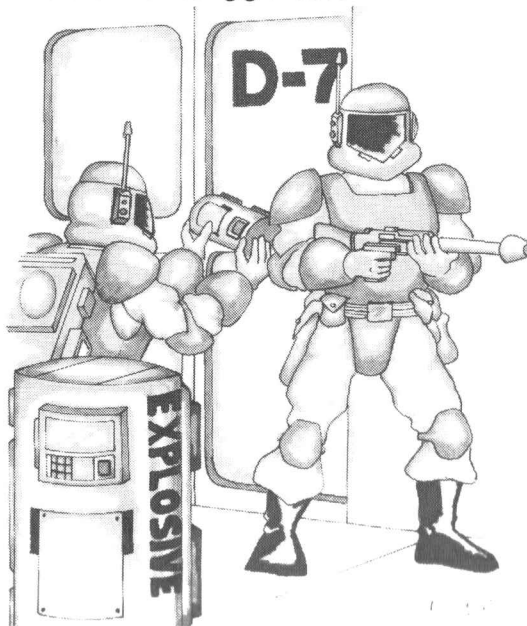

YOUR MARINES

Rockets will explode around friendly troops. Rockets will also detonate fuel tanks in the same fashion as blasters. Caution must be exercised when using rockets!

Rockets explode in a 3 by 3 pattern, with the target in the center. Each square receives the equivalent of a hit from a 90% blaster.

Caution: Firing rockets at targets not readily visible may result in damage to other marines or destruction of necessary mission objectives.

Psionic Stun – Only marines with the specialty of psionic talent can make a psionic stun attack. If a stun attack is successful, the affected target will be stunned for the next combat round. In addition, since vitality can regenerate at a rate of 25% per round maximum, it will take several rounds before the affected target is back to full movement strength.

Psionic stuns will not travel through closed doors or walls. It is possible to stun your own troops, so look before you stun!

Types of Marines

Squad Leader – The squad leader is your main character. This is the only type of marine who is created independently of any scenarios.

The long-range goal of Breach is to improve this character, so it is very important that he (or she) does not get killed in combat. If this happens, the squad leader's file will be erased. On the other hand, in order to improve your squad leader's attributes, he must be an integral part of any mission. As the mission difficulty level rises, you will find it more and more necessary to use the squad leader in dangerous situations.

Squad leaders have a very powerful blaster (75% damage) and heavy protective armor. A squad leader is the only marine in a squad who can absorb several hits from a battle robot.



YOUR MARINES

Marauder – The marauder is the basic marine. They carry a heavy blaster and they have a fairly high level of mobility.

Marauders usually comprise the majority of any squad.

Scout – Scouts have very light, fast armor, and carry the same guns as marauders.

Scouts usually carry detectors. They are used when it is important to survey the battle area or find mission objectives (possible prison areas, etc.).

Infiltrator – Infiltrators have the same armor as scouts but a slightly lighter gun.

Infiltrators usually carry crack units. They are used when you need the floor plans for the current level.

Psionic Talent – Psionic talents wear the same armor as scouts and infiltrators but they carry a very weak gun. This gun is only effective against heavily wounded enemy troops.

THE OPPONENTS

Basic Characteristics

All of the intelligent enemies will guard any mission objectives that are in their area. If a marine is in the same area as a datapack, there aren't any player marines around, and capturing datapacks is an objective, then the enemy will guard the datapack until a player marine enters the area.

The smaller intelligent enemies (overlords, marines, aliens) will use the shafts.

Enemy marines, overlords, and aliens all can have psionic ability. Overlords and aliens almost always do. Their tendency is to stun their target in one round and shoot them in the next.



Marines

The enemy marines are all of the marauder type, but certain scenarios have weakened or enhanced marines to simulate squad leaders, scouts, etc.

Enemy marines will use rockets and grenades against your troops.

Beasts

Beasts are slow and their only armor is their hide, but in large quantities they can be very dangerous. Beasts attack by biting and a bite is the equivalent of a 45% blaster hit. A beast can only attack adjacent squares.

Aliens

Aliens are lightly armored and very fast. They will use an effective combination of psionic, grenade, and rocket attacks against your marines. Fortunately, their blasters are rather weak and almost ineffective against marauders and squad leaders.

THE OPPONENTS

Battle Robots

Battle robots are the most dangerous of all opponents. A battle robot is very mobile and the twin blaster cannon it carries will destroy all but the luckiest marine with just two hits.

Robots do not use rockets or grenades.

Robots cannot use shafts but they can pass through doors.

Overlords

Overlords are the elite of the enemy marines.

Overlords come equipped with a short range vibrosword which generates 55% damage. Using the vibrosword, the overlord can only attack adjacent squares, but overlords almost invariably are psionic talents.

Overlords have very little armor, relying instead on fast and deadly attacks. When forced into a defensive posture, they are quickly killed.

Overlords do not use grenades or rockets.



Autoguns

Autoguns are the fixed equivalent of battle robots. The only differences between the two are that autoguns don't move and that they generally are more accurate.

These are also very dangerous opponents and must be treated with extreme caution.

OBJECTS AND THEIR USES

Encumbrance Points

There are fifteen different types of objects which may be found in a scenario. Each of those objects has an encumbrance value. Encumbrance is a measure of the object's bulk. Obviously, the bulkier the type of object, the fewer of them the marine may carry.

<u>Object</u>	<u>Encumbrance Points</u>
Grenade	1
Demo Charge	5
Stimulant	1
Ammo	2
MediKit	3
Rocket	3
Launcher	7
Crack Unit	9
Detector	9
Shield	1
Grav Belt	6
Prisoner	1
Datapack	1

Marines carrying a large number of encumbrance points are subject to movement point loss.

What They Are and How to Use Them

Grenade— A short-range energy grenade.

When a grenade is selected, the mouse pointer turns into a crosshair. Place this crosshair over any point on the same row or column as the current marine and click. The marine does not need to be facing the target.

Demo Charge— A medium range energy demolition charge.

When a demo charge is selected, the program confirms that you actually want to use a demo charge. If you click 'yes', the demo charge will be dropped in the same square as the current marine. When the current marine's turn is over (running out of mp's, selecting another marine, or clicking the "Next" button) the demo charge will explode.

OBJECTS AND THEIR USES

Stimulant — A one-use syringe of a potent metabolic accelerator. A shot of stimulant will raise the marine's vitality level by 50%, up to 100% maximum. If the marine's health is 50% or less, there is the possibility that he may die from heart-shock.

When a stimulant is selected, the current marine will use the stimulant.

Ammo Clip — Holds ammunition for the blasters that each marine carries. The ammo clip is compatible with all of the different types of blasters.

When an ammo clip is selected, the current marine will add the contents of the ammo clip to his current ammo supply. Each clip holds 50 rounds.

MediKit — Use of the medikit raises the marine's health level by 50%, up to 100% maximum.

When the medikit is selected, the current marine will use it.

Rocket — Basically a flying version of the grenade. A rocket must be fired with a launcher.

When a rocket is selected, the current marine must also have a launcher in order to use it. The rocket will be fired in the direction of the current marine's facing and will fly until it hits a target or leaves the playing field. A rocket has the same destructive force as a grenade.

Launcher — A light multiple-use rocket launcher.

When a launcher is selected, the current marine must also have a rocket in order to use it. A rocket will be fired in the direction of the current marine's facing and will fly until it hits a target or leaves the playing field.

Crack Unit — A crack unit is a special device primarily intended for use by Infiltrator (IF) marines. If it is successfully operated next to a computer or terminal, it will dump all of the floor plans for the current level from the opponent's computer system.

When a crack unit is selected and successfully operated, it will reveal all of the wall and interior squares on the current marine's level and integrate this data with any landscape which has already been revealed by movement, et cetera. If the current marine is not next to a terminal or computer, the crack unit will not reveal any new information and it will show only the information which has been gathered thus far.

OBJECTS AND THEIR USES

Detector — The detector is a special device primarily intended for use by Scout (SC) marines which creates a radar scan of the surrounding terrain. If operated by a Scout, the detector will also reveal any enemy marines within range and display them as flashing green squares on the Atari ST and as grey squares on the Macintosh.

When a crack unit is selected and successfully operated, it reveals a 17 by 17 area of the current level, centered around the current marine. It will also integrate this data with any landscape which has already been revealed by movement. If the scan is not successful, it will show only the information which has been gathered thus far.

Shield — A shield will absorb any incoming firearms, vibrosword, or psionic attacks, friend or foe. A shield does not protect against grenades, rockets or demo charges. In order to protect a marine, the shield must be in a square between the marine and the enemy firing at him. If a marine is in the same square as a shield, the shield will not protect him. Every time a shield is hit, there is a 10% chance it will be destroyed.

This object does not need to be used because it activates automatically when dropped.

Grav Belt — a marine using the grav belt will float above the ground, ignoring terrain costs and movement restrictions. The only terrain types a belt will not move through are closed doors, solid rock, and walls. Every time a grav belt is used, there is a 10% chance that the marine will crash at the end of his turn.

When a grav belt is selected, it remains active until the marine runs out of movement points, you click the use icon again, select a different marine, or click the Next button. Once a grav belt is on, you may not take or drop objects, use shafts, open doors, use objects, fire the gun, or use psionic power until the belt has been switched off. If the marine ends his turn over either a blank or a water square, he will be killed and removed from the game.

Data Pack — Data packs are used for storing information.

A data pack cannot be used.

Prisoner — Prisoners are captured personnel from your own government.

A prisoner cannot be used.

TERRAIN

Interior Terrain

Walls – The walls come in four types: heavy, medium, thin, and storage. Demo charges will destroy any type of wall; grenades will destroy only thin and storage type walls. Gunfire will not penetrate walls at all.

Marines cannot pass through or fly above walls squares using a gravbelt.

Doors – Marines cannot move through closed doors.

Glass doors require 3 mp to open, steel doors require 5 mp, and power doors require 10 mp to open.

Marines cannot fly above doors squares using a gravbelt.

Exterior Terrain

Water – Marines cannot pass through water squares, although they can fly over them if they are using a gravbelt.

If a marine using a gravbelt ends his turn over a water square, he will be killed and removed from the game.

Solid Rock – Marines cannot fly over or through solid rock squares.

Special Terrain

Shafts – Shafts require 5 mp to enter, and another 5 mp to use.

The Entry Square – In order for your marines to enter the combat zone, this square must not be blocked.

The Exit Square – If the current marine is on this square at the end of his turn, he will be removed from the combat zone and will no longer be allowed to fight.

Stun Fields – When a marine passes through a stun field, there is a chance that he will be stunned and unable to move. This chance is inversely proportional to the marine's vitality. For example, if a marine with a vitality of 78% passes through a stun field, there is a 22% chance that he will be stunned.

Empty (Black) Squares – Marines cannot pass through these squares, although they can fly over them if they are using a gravbelt.

If a marine using a gravbelt ends his turn over a black square, he will be killed and removed from the game.

Terrain Table

Type	MP's to Enter	Special Comments...
Walls (All Types)	No Move	Cannot be flown over.
Half Dirt/Half Empty	No Move	Can be flown over with grav belt.
Half Blank/Half Empty	No Move	Cannot be flown over.
Blank	No Move	Can be flown over with grav belt.
Solid Rock	No Move	Cannot be flown over.
Empty Interior	2	
Dirt	2	
Grass	2	
Light Vegetation	4	
Heavy Vegetation	6	
Rocky Dirt	4	
Interior Rubble	4	
Stun Field	8	
Water	No Move	Can be flown over with grav belt.
Stepping Stones	4	
Grating	3	
Dropshaft	5	
Liftshaft	5	
Closed Doors	No Move	Cannot be flown over.
Open Doors	4	Can be flown over with grav belt.
Computer	5	
Terminals	5	
Bed	5	
Bureau	6	
Table	5	
Small Chairs	4	
Worker	6	
Entry Square	3	
Exit Square	3	
Machines	No Move	Can be flown over with grav belt.
Half Water/Half Dirt	4	
Half Water/Half Empty	4	
Command Chairs	4	

SCENARIO BUILDER

Breach includes a scenario builder that allows you to create your own scenarios or modify existing ones. To start the scenario builder, double click the "SCENARIO" icon (Macintosh players should use the "Quit to scenario" option in the Breach program).

File Menu

New – opens the mapping window and creates a new Breach scenario file.

Open – opens an existing scenario file and displays it in the mapping window. The Open function will automatically display all available Breach scenario files.

Close – closes the current mapping window and disposes of the scenario file. If the scenario file has been modified, the computer will ask you if you wish to save the scenario file before closing it. Clicking the "go-away" box on the upper left corner of the mapping window does the same thing as selecting Close.

Save – saves the scenario file currently in progress. If the current file is untitled, it acts in the same fashion as Save As.

Save as – saves the current scenario file.

Quit – exits Scenario Builder.

Edit Menu

Whole View – generates a compressed view of the entire current map level. Click the mouse to return to the normal mapping mode. If the click occurs on the whole view map, the window will jump to the equivalent position in the normal mapping mode. This serves as a shortcut for moving about the map.

Thread Object – jumps sequentially through the list of objects which have been placed on the map. When it jumps to the next object on the list, it moves the map so that the object is in the center of the screen.

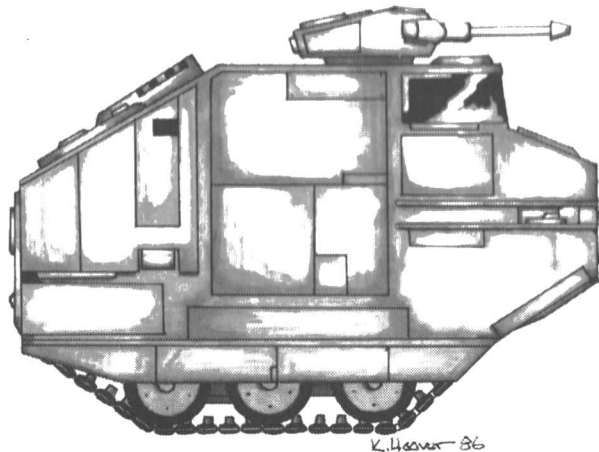

Thread Opponent – jumps sequentially through the list of opponents which have been placed on the map. When it jumps to the next opponent on the list, it moves the map so that the opponent is in the center of the screen.

Fill Level – fills the current level with the currently selected terrain type. Fill Level will not overwrite objects or opponents.

Copy Level – copies the contents of the current level to another level, excluding objects and opponents.

Briefing – is the area where you enter information for the player about the scenario you have created. This might be part of a story, or just some technical information.

On the Atari ST version, use the Arrow keys, Return, and the Backspace key to edit your entry (the Delete key is not supported).

Set Victory – sets the victory conditions for the scenario. Rescue Prisoners means the player must take all of the prisoners in the scenario to win. Capture Data Packs works the same way. Exit Combat Zone means all of the marines who are still living must go through the exit square. Kill % Opponents requires the player to kill at least the percentage of opponents entered in the box to win.

The scenario time limit must be set for every scenario. The other victory conditions must be met before the amount of time entered in the box expires. Time is in an hours/minutes/seconds format.

The victory conditions can be used in combination. This means that if you select kill 20% and rescue prisoners, you must kill at least 20% of the opponents and rescue all of the prisoners to win.

New Marine – generates a marine for the player's squad. Name the character and select the character's specialty using the radio-type buttons. The different specialties generate different basic characteristics. A squad can have up to 19 marines.

Modify Marine – is used to change the basic characteristics of the scenario marines. A list box will appear with the names of all the marines currently in the squad. Select a marine by clicking on his name. Delete will remove a marine from the squad. The Change button jumps to another screen, where a marine's attributes can be modified.

New Leader – is used to generate a Squad Leader. This character is independent of any scenario. (You can generate a Squad Leader without opening the map window.) After you have named the Squad Leader, Create Leader saves the Squad Leader file, after asking for a file name. The attributes of the Squad Leader may not be modified directly: they only increase through actual combat experience.

SCENARIO BUILDER

Examine Leader – shows a Squad Leader's current statistics. After you select a Squad Leader file name, his statistics are displayed.

Level Menu

Use the Level menu to select the level of the scenario map being shown in the mapping window. There are 5 levels in all.

Palette Menu

The Palette menu controls the parts & terrain palette.

The blank squares found on the objects and opponents palettes will only erase objects and opponents, not the underlying terrain. If a part will not appear where you have clicked, then it cannot be placed on that type of terrain. A scenario can have up to 30 objects and 40 opponents.

Other Functions

Click any terrain square on the palette to select it. Clicking on the map window will place that square on the map.

Holding a Shift key and clicking on an enemy character will display the Modify Opponent dialog window. Use this to change opponent attributes.

Holding the Shift Key and clicking on an object allows you to write a short message which will appear whenever the player picks up that particular object. This can be used to hide clues within the game.

Scenario Design Notes

Avoid Featurism

A scenario could have 5 levels, 20 marines in the squad, 40 opponents, and 30 objects. Resist the temptation! Scenarios are generally more successful if they are quick to start and play. Having to move 20 marines through a maze for 40 Player phases is not fun.

SCENARIO BUILDER

Supermen Not Wanted Here

Imagine a squad of 20 marines, each with the maximum of everything against a band of normal enemies. Boring! Winning all the time is not the point of the game. Try and create scenarios in which the player must logically deploy his forces. Good scenarios should be a test of the player's decision-making ability, not the random number generator.

Liftshafts, Dropshafts, and Levels

The map in Breach uses up to five levels. These levels are organized like the floors of a building, with Level 1 being the bottom level and Level 5 being the top level.

A liftshaft always moves a marine from a lower level to the next higher one. Thus, using a liftshaft on Level 3 would move the marine to the corresponding square on Level 4. A liftshaft on Level 5 will not work.

A dropshaft always moves a marine from a higher level down to the next lower one. Thus, using a dropshaft on Level 3 would move the marine to the corresponding square on Level 2. A dropshaft on Level 1 will not work.

The corresponding square above a liftshaft must be clear in order for it to work.

The corresponding square below a dropshaft must be clear in order for it to work.

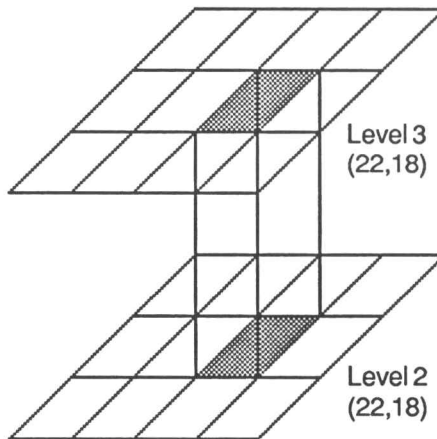

Corresponding squares on Levels 2 and 3.

THE SCENARIOS

Included with your game are many scenarios that you can play and modify. Five of these scenarios are outlined and rated below.

Breeder

by Haywood Nichols & Bill Leslie

Difficulty Rating: Easy

Synopsis: Wipe out an alien installation where man-eating beasts are being developed and rescue the Federated World citizens who are being used as test subjects.

Strategy: Keep an eye on the mission status. Avoid spreading your forces to areas where they are not needed.

Towers

by Bill Leslie

Difficulty Rating: Medium

Synopsis: Recover an important datapack from the top of a heavily-defended building.

Strategy: Since you are not provided with very many troops, you must discover an alternate route to the top of the UDP building.

Odysseus

by Haywood Nichols

Difficulty Rating: Hard

Synopsis: Capture a United Democratic Planets warship by eliminating 90% of its crew and recovering any datapacks or prisoners that might be on board.

Strategy: Conserve your supplies for later in the scenario and distribute them evenly among your squad.

Depot

by Haywood Nichols

Difficulty Rating: Very Hard

Synopsis: Destroy a well-established UDP supply depot.

Strategy: Depot takes place on a very large map. Remember to use the crack unit as soon as possible. Dividing your forces into two squads is a good idea.

Island

by Bill Leslie

Difficulty Rating: STAR Level

Synopsis: A single man mission to rescue Admiral Bresheliah from the depths of a UDP installation.

Strategy: Speed is of the essence — try not to over-burden yourself. The recovery ship is due east of the emergency exit grid square. Don't even bother if your squad leader isn't a STAR team member.



OMNITREND
S O F T W A R E

P.O. BOX 733 • WEST SIMSBURY, CT 06092